

CERMET SINGLE TURN TYPE

JP series

RoHS compliant

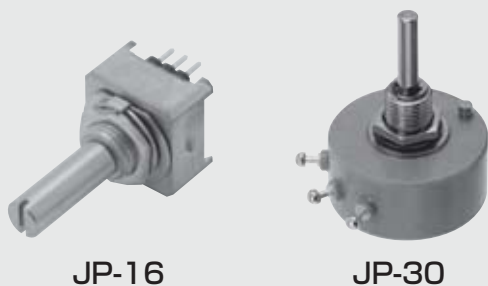

Basic construction

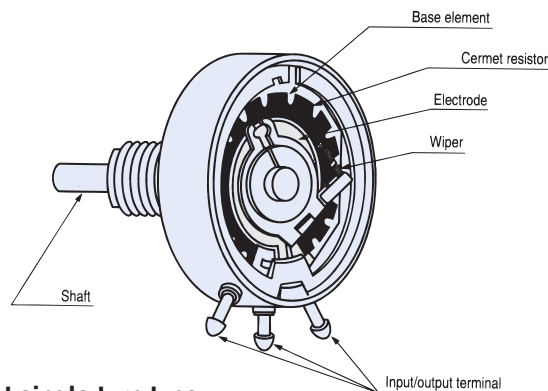

Cermet single turn type

FEATURES

- Cost effective (In house comparison)
- High resolution (Essentially infinite)
- RoHS compliant

PART NUMBER DESIGNATION

JP-16-C1k

Series name

JP-16 : For sensor
JP-30 : For sensor

Snap-in holder

Blank : Without
C : With

Nominal resistance value (Ω)

500, 1 k, 2 k, 5 k, 10 k, 20 k, 50 k, 100 k

STANDARD SPECIFICATIONS

Item	Part number	JP-16	JP-30
Resistance tolerance	%	± 2	
Resolution		Essentially infinite	
Independent linearity	%	± 0.5	
Effective electrical angle		300° ± 1°	
Mechanical angle		360° continuous	
Power rating (at 40 °C)	W	1.0	1.5
Dielectric strength	Vrms	1000 1 min	
Insulation resistance	MΩ minimum	1000 (at DC500 V)	
Rotational torque	mN·m {gf·cm}	2.94 {30} maximum	
Peak noise		2 % or 100 Ω, whichever is greater	
Temp. coefficient resistance	10 ⁻⁶ /°C	± 150	
Operating temp. range	°C	-55 ~ 85	
Maximum rotational speed	r/min	150	
Rotational life		3 million revolution	
Net weight	g	Approx. 15	Approx. 26
Strength of tighten screw		0.98 N·m {10 kgf·cm} maximum	

* Perform soldering of the terminals at 380 °C for no more three seconds, and avoid applying excess heat. Also, avoid applying outside force to the terminals.
In case of using multiturn potentiometers, when rotating the shaft to the mechanical limit, apply torque below the strength of the stopper. Also, give due consideration to thrust and radial loading.

LIST OF PART NUMBERS

Application	Series name	Mounting bracket	Nominal resistance value	Part number
For sensor	JP-16	Without	500 Ω	JP-16 500
			1 kΩ	JP-16 1 k
			2 kΩ	JP-16 2 k
			5 kΩ	JP-16 5 k
			10 kΩ	JP-16 10 k
			20 kΩ	JP-16 20 k
			50 kΩ	JP-16 50 k
		100 kΩ	JP-16 100 k	
		With	500 Ω	JP-16-C 500
			1 kΩ	JP-16-C 1 k
			2 kΩ	JP-16-C 2 k
			5 kΩ	JP-16-C 5 k
			10 kΩ	JP-16-C 10 k
			20 kΩ	JP-16-C 20 k
	50 kΩ		JP-16-C 50 k	
	JP-30	Without	500 Ω	JP-30 500
			1 kΩ	JP-30 1 k
			2 kΩ	JP-30 2 k
			5 kΩ	JP-30 5 k
			10 kΩ	JP-30 10 k
			20 kΩ	JP-30 20 k
50 kΩ			JP-30 50 k	
100 kΩ	JP-30 100 k			

※Verify the above part numbers when placing orders.

NOMINAL RESISTANCE VALUE · RATED VOLTAGE · RATED CURRENT

Nominal resistance value (Ω)	JP-16		JP-30	
	Rated voltage (V)	Rated current (mA)	Rated voltage (V)	Rated current (mA)
500	22.4	44.7	27.3	54.7
1 k	31.6	31.6	38.7	38.7
2 k	44.7	22.4	54.7	27.3
5 k	70.7	14.1	86.6	17.3
10k	100	10.0	122	12.2
20 k	141	7.07	173	8.66
50 k	224	4.47	273	5.47
100 k	316	3.16	387	3.87

RATED POWER DERATING CURVE

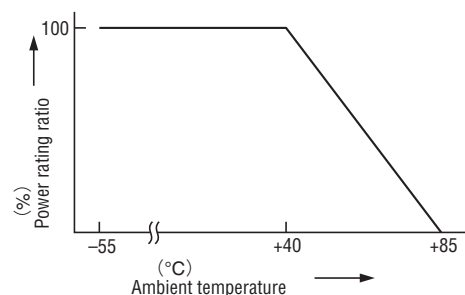

JP POTENTIOMETERS

OUTLINE DIMENSIONS

Unless otherwise specified, tolerance: ± 0.5 (Unit: mm)

● JP-16

For sensor

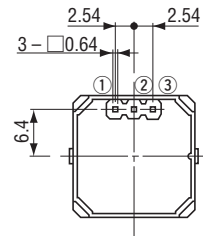
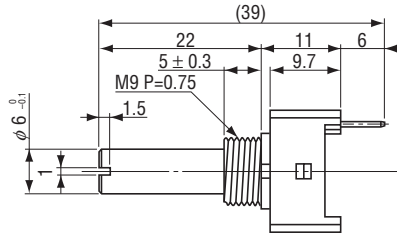
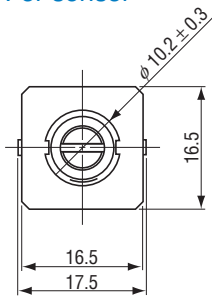

Wiring diagram

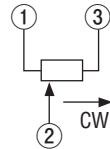

● JP-16-C

For sensor with mounting bracket

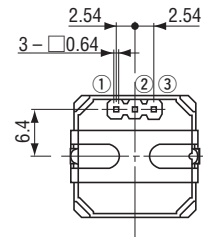
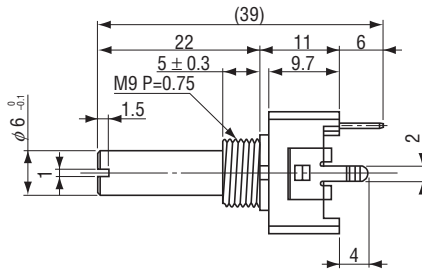
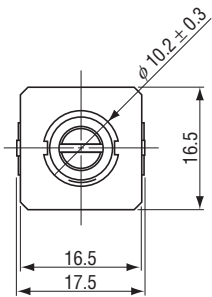

● JP-30

For sensor

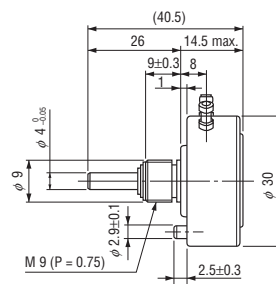
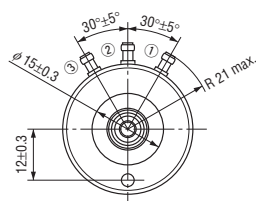

(Accessories)

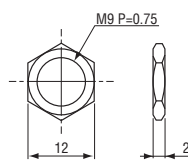

1. Nut

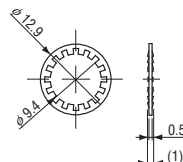

2. Washer

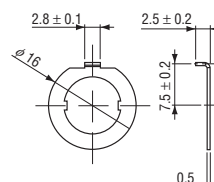

3. Locking ring (JP-16)