

OEM relative and absolute pressure transmitter type 511

Pressure range
-1 ... 0 – 600 bar



Type 511 pressure transmitters meet the highest specifications for longevity, accuracy, temperature stability and EMC characteristics, making them suitable for an extremely wide range of demanding industrial applications.

- Compact, rugged construction for highest operational reliability
- No media egress when exceeding rupture pressure (patented)
- Negligible temperature influence on accuracy
- Excellent EMC capacity
- Saving time by quick cable mounting by the customer with swift connector

Technical overview

Pressure range

Relative	-1 ... 0 – 600 bar
Absolute	0 ... 25 bar

Operating conditions

Medium		Liquids and gases
Temperature		FPM
		EPDM
		NBR
		FPM spec.
	Ambient ¹⁾	ratiom. output, AMP JPT
	all other versions	
Tolerable overload / repute pressure ²⁾		-1 ... 4 bar
		6 ... 600 bar

Materials

Case		Stainless steel 1.4305 / AISI 303
Materials in contact with the medium	Pressure connection	Stainless steel 1.4305 / AISI 303
	Sensor	Ceramic Al ₂ O ₃ (96%)
	Media stop system	PPS
	Sealing material	FPM, EPDM, NBR, FPM spec.

Media stop system

Patented media stop system to prevent media egress when exceeding rupture pressure range (> 40 bar nominal value).

Electrical overview

	Output	Power supply	Load	Current consumption ⁴⁾
2 wire	4 ... 20 mA	8.0 ... 33 VDC	< $\frac{\text{supply voltage} - 8\text{V}}{0.02\text{A}}$ [Ohm]	< 20 mA
	0 ... 5 V	8.0 ... 33 VDC	>10 kOhm / < 100 nF	< 4 mA
	1 ... 6 V	8.0 ... 33 VDC	>10 kOhm / < 100 nF	< 4 mA
3 wire	0 ... 10 V	11.4 ... 33 VDC	>10 kOhm / < 100 nF	< 4 mA
	0 ... 10 V	24 VAC ±15%	>10 kOhm / < 100 nF	< 4 mA
	ratiom. 10 ... 90%	5 VDC ±5%	>10 kOhm / < 100 nF	< 4 mA
Polarity reversal protection	Short circuit proof and protected against polarity reversal. Each connection is protected against crossover up to max. supply voltage.			
Insulation voltage			standard	500 VDC
			optional	1000 VDC

Dynamic response

Response time	< 2 ms, typ. 1 ms
Load cycle	< 100 Hz

Protection standard

With connector DIN EN 175301-803-C	IP 65
All other versions	IP 67

Electrical connection

Cable 1.5 m
Swift connector
Connector AMP (Junior power time)
Connector M12x1 plastic thread
Connector M12x1 metal thread
Connector DIN EN 175301-803-C (mini-DIN)

Pressure connection

Inside thread	G ¼ with O-Ring seal
	G ¼ sealed at back, DIN 3852, form E
	G ½ sealed at front
Outside thread	G ½ sealed at back and manometer (combi)
	¼ -18 NPT
	R ¼, DIN 2999
	M12x1.5, sealed at back, DIN 3852, form E
	M14x1.5, sealed at back, DIN 3852, form E

Installation arrangement

Unrestricted

Tests / Admissions

Electromagnetic compatibility	CE conformity acc. EN 61326-2-3
UL	acc. Standard 873
Shock acc. IEC 60068-2-27	100 g, 11 ms half sine wave, all 6 directions. Free fall from 2 m on concrete (6x)
Constant shock acc. IEC 60068-2-29	40 g for 6 ms, 1000 x all 3 directions
Vibration acc. IEC 60068-2-6	20 g, 2 ... 2000 Hz with amplitude ± 15 mm, 1 Octave/min. all 3 directions, 50 constant load

Weight

Version with inside thread	~ 85 g
Version with outside thread	~ 95 g

Packaging (Please state on order)

Single packaging in cardboard	accessories integrated
Multiple packaging in cardboard (25 pcs)	accessories integrated

¹⁾ Version until +150 °C on request

²⁾ higher overload and rupture pressure on request

³⁾ at nominal pressure

Accuracy

Parameter		Unit	
Tolerance zero point	max.	% fs	±0.3
Tolerance full scale	max.	% fs	±0.3
Resolution		% fs	0.1
Total of linearity, hysteresis and repeatability	max.	% fs	±0.3
Long term stability acc. DIN EN 60770		% fs	±1.0
TC zero point ¹⁾	max.	% fs/10K	±0.15
TC sensitivity ¹⁾	max.	% fs/10K	±0.15

Test conditions: 25 °C, 45% RH, power supply 24 VDC
TC z.p. / TC s. -40 ... +125 °C

Order code selection table in bar

				511.	X	X	X	X	X	X	X	X	X	X	
Pressure mode	Relative			9											
	Absolute			8											
Pressure range ²⁾	-1 ... + 0 bar			9	0	0									
	0 ... + 1 bar				1	1									
	0 ... + 1.6 bar				1	2									
	0 ... + 2.5 bar				1	4									
	0 ... + 4 bar				1	5									
	0 ... + 6 bar				1	7									
	0 ... + 10 bar				3	0									
	0 ... + 16 bar				3	1									
	0 ... + 25 bar				3	2									
	0 ... + 40 bar				9	3	3							2	
	0 ... + 60 bar				9	4	0							2	
	0 ... + 100 bar				9	4	1							2,5	
	0 ... + 160 bar				9	4	2							2,5	
	0 ... + 250 bar	not free of oil and grease			9	4	3							2,5	
	0 ... + 400 bar	not free of oil and grease (FPM spec. seal only)			9	5	4	6						2,5	
0 ... + 600 bar	not free of oil and grease (FPM spec. seal only)			9	5	5	6						2,5		
▲ Full scale signale at these pressures															
Sealing material ²⁾	FPM	Fluoro elastomer					0								
	EPDM	Ethylene propylene					1								
	NBR	Butadiene Acrylonitrile					2								
	FPM spec.	Fluoro elastomer spec.					6								
Adjustment	Factory							0							
Output / power supply	0 ... 5 V	8.0 ... 33 VDC	IN=1 / OUT=3 / GND=4										1		
	1 ... 6 V	8.0 ... 33 VDC	IN=1 / OUT=3 / GND=4										6		
	0 ... 10 V	11.4 ... 33 VDC	IN=1 / OUT=3 / GND=4										2		
	0 ... 5 V	8.0 ... 33 VDC	IN=1 / OUT=4 / GND=3										F	5,7	
	1 ... 6 V	8.0 ... 33 VDC	IN=1 / OUT=4 / GND=3										G	5,7	
	0 ... 10 V	11.4 ... 33 VDC	IN=1 / OUT=4 / GND=3										H	5,7	
	0 ... 10 V	24 VAC ±15%											7	1,0	
	4 ... 20 mA	8.0 ... 33 VDC											3		
	ration. 10 ... 90%	5 VDC ±5%											4		
	Electrical connection	Cable 1.5 m													0
Swift connector														1	
Connector AMP JPT ⁴⁾														2	
Connector M12x1 plastic thread ⁴⁾														5	
Connector M12x1 metal thread ⁴⁾														7	
Connector DIN EN 175301-803-C (mini DIN) 2 w: IN=3 / OUT=1 3 w: IN=3 / OUT=2 / GND=1															8
Connector DIN EN 175301-803-C (mini DIN) 2 w: IN=1 / OUT=2 3 w: IN=1 / OUT=3 / GND=2															9
Pressure connection ⁵⁾		Inside thread	G ¼ mit O-Ring seal												1
	Outside thread	G ¼ sealed at back, DIN 3852, form E												4	
	Outside thread	G ½ sealed at front												9	
	Outside thread	G ½ sealed at back and manometer (combi)												8	
	Outside thread	¼ -18 NPT												3	
	Outside thread	R ¼, DIN 2999												7	
	Outside thread	M12x1.5, sealed at back, DIN 3852, form E												5	
	Outside thread	M14x1.5, sealed at back, DIN 3852, form E												6	
Version	Stainless steel without media stopper													1	
	Stainless steel with media stopper (standard from 40 bar)													2	
	Stainless steel with media stopper, free of oil and grease (FPM spec. seal only)							6						3	
	Stainless steel with pressure tip orifice (from 100 bar)													5	
Pressure range variation	Indicate W and state range on order (e.g.: W0... + 8bar/OUT1...6V)													W	

Accessories

	Order number
Female connector for connector M12x1	106975
Female connector AMP (Junior power timer) 2-wire	110442
Female connector AMP (Junior power timer) 3-wire	108767
Female connector swift connector (included in delivery)	107359
Female connector mini DIN	104244
Calibration certificate	104551

¹⁾ TC = Temperature coefficient

²⁾ Other pressure range on request

³⁾ Other sealing material on request

⁴⁾ Delivery without female connector

⁵⁾ Other pressure connection on request

Order code selection table in psi			511. X X X X X X X X X X X																				
Pressure mode	Relative		9																				
	Absolute		8																				
Pressure range ¹⁾	-30 ... + 0" hg		9	A	0																		
	0 ... + 15 psi			B	1																		
	0 ... + 30 psi			B	4																		
	0 ... + 60 psi			B	5																		
	0 ... + 100 psi			B	7																		
	0 ... + 200 psi			C	1																		
	0 ... + 300 psi			C	2																		
	0 ... + 500 psi		9	C	3															2			
	0 ... + 700 psi		9	D	0																2		
	0 ... +1000 psi		9	D	1																2,5		
	0 ... +2000 psi		9	D	2																2,5		
	0 ... +3000 psi	not free of oil and grease		9	D	3															2,5		
	0 ... +5000 psi	not free of oil and grease (FPM spec. seal only)		9	E	4	6														2,5		
	0 ... +7500 psi	not free of oil and grease (FPM spec. seal only)		9	E	5	6														2,5		
▲ Full scale signale at these pressures																							
Sealing material ²⁾	FPM	Fluoro elastomer																			0		
	EPDM	Ethylene propylene																			1		
	NBR	Butadiene Acrylonitrile																			2		
	FPM spec.	Fluoro elastomer spec.																			6		
Adjustment	Factory																				0		
Output / power supply	0 ... 5 V	8.0 ... 33 VDC	IN=1 / OUT=3 / GND=4																		1		
	1 ... 6 V	8.0 ... 33 VDC	IN=1 / OUT=3 / GND=4																		6		
	0 ... 10 V	11.4 ... 33 VDC	IN=1 / OUT=3 / GND=4																		2		
	0 ... 5 V	8.0 ... 33 VDC	IN=1 / OUT=4 / GND=3																		F	5,7	
	1 ... 6 V	8.0 ... 33 VDC	IN=1 / OUT=4 / GND=3																		G	5,7	
	0 ... 10 V	11.4 ... 33 VDC	IN=1 / OUT=4 / GND=3																		H	5,7	
	0 ... 10 V	24 VAC ±15%																				7	1,0
	4 ... 20 mA	8.0 ... 33 VDC																				3	
	ratiom. 10 ... 90%	5 VDC ±5%																				4	
	Electrical connection	Cable 1.5 m																					0
Swift connector																						1	
Connector AMP JPT ⁴⁾																						2	
Connector M12x1 plastic thread ⁴⁾																						5	
Connector M12x1 metal thread ⁴⁾																						7	
Connector DIN EN 175301-803-C (mini DIN) 2 w: IN=3 / OUT=1 3 w: IN=3 / OUT=2 / GND=1																							8
Connector DIN EN 175301-803-C (mini DIN) 2 w: IN=1 / OUT=2 3 w: IN=1 / OUT=3 / GND=2																							9
Pressure connection ⁵⁾	Inside thread	G ¼ mit O-Ring seal																				1	
	Outside thread	G ¼ sealed at back, DIN 3852, form E																				4	
	Outside thread	G ½ sealed at front																				9	
	Outside thread	G ½ sealed at back and manometer (combi)																				8	
	Outside thread	¼ -18 NPT																				3	
	Outside thread	R ¼, DIN 2999																				7	
	Outside thread	M12x1.5, sealed at back, DIN 3852, form E																				5	
	Outside thread	M14x1.5, sealed at back, DIN 3852, form E																				6	
Version	Stainless steel without media stopper																					1	
	Stainless steel with media stopper (standard from 500 psi)																					2	
	Stainless steel with media stopper, free of oil and grease (FPM spec. seal only)																				6	3	
	Stainless steel with pressure tip orifice (from 1000 psi)																					5	
Pressure range variation	Indicate W and state range on order (e.g.: W0... + 120psi/OUT1...6V)																			W			

¹⁾ Other pressure range on request ²⁾ Other sealing material on request ³⁾ Delivery without female connector ⁴⁾ Other pressure connection on request

Order code selection table in MPa				511. X X X X X X X X X X X																		
Pressure mode	Relative			9																		
	Absolute			8																		
Pressure range ¹⁾	-0.1 ... + 0 MPa			9	F	0																
	0 ... + 0.1 MPa				G	1																
	0 ... +0.16 MPa				G	2																
	0 ... +0.25 MPa				G	4																
	0 ... + 0.4 MPa				G	5																
	0 ... + 0.6 MPa				G	7																
	0 ... + 1 MPa				H	0																
	0 ... + 1.6 MPa				H	1																
	0 ... + 2.5 MPa				H	2																
	0 ... + 4 MPa			9	H	3															2	
	0 ... + 6 MPa			9	K	0																2
	0 ... + 10 MPa			9	K	1																2,5
	0 ... + 16 MPa			9	K	2																2,5
	0 ... + 25 MPa	not free of oil and grease		9	K	3																2,5
	0 ... + 40 MPa	not free of oil and grease (FPM spec. seal only)		9	L	4	6															2,5
0 ... + 60 MPa	not free of oil and grease (FPM spec. seal only)		9	L	5	6															2,5	
▲ Full scale signale at these pressures																						
Sealing material ²⁾	FPM	Fluoro elastomer				0																
	EPDM	Ethylene propylene				1																
	NBR	Butadiene Acrylonitrile				2																
	FPM spec.	Fluoro elastomer spec.				6																
Adjustment	Factory									0												
Output / power supply	0 ... 5 V	8.0 ... 33 VDC	IN=1 / OUT=3 / GND=4																		1	
	1 ... 6 V	8.0 ... 33 VDC	IN=1 / OUT=3 / GND=4																		6	
	0 ... 10 V	11.4 ... 33 VDC	IN=1 / OUT=3 / GND=4																		2	
	0 ... 5 V	8.0 ... 33 VDC	IN=1 / OUT=4 / GND=3																		F 5,7	
	1 ... 6 V	8.0 ... 33 VDC	IN=1 / OUT=4 / GND=3																		G 5,7	
	0 ... 10 V	11.4 ... 33 VDC	IN=1 / OUT=4 / GND=3																		H 5,7	
	0 ... 10 V	24 VAC ±15%																			7 1,0	
	4 ... 20 mA	8.0 ... 33 VDC																			3	
	ration. 10 ... 90%	5 VDC ±5%																			4	
Electrical connection	Cable 1.5 m																				0	
	Swift connector																				1	
	Connector AMP JPT ⁴⁾																				2	
	Connector M12x1 plastic thread ⁴⁾																				5	
	Connector M12x1 metal thread ⁴⁾																				7	
	Connector DIN EN 175301-803-C (mini DIN) 2 w: IN=3 / OUT=1 3 w: IN=3 / OUT=2 / GND=1																					8
	Connector DIN EN 175301-803-C (mini DIN) 2 w: IN=1 / OUT=2 3 w: IN=1 / OUT=3 / GND=2																					9
Pressure connection ⁵⁾	Inside thread	G ¼ mit O-Ring seal																			1	
	Outside thread	G ¼ sealed at back, DIN 3852, form E																			4	
	Outside thread	G ½ sealed at front																			9	
	Outside thread	G ½ sealed at back and manometer (combi)																			8	
	Outside thread	¼ -18 NPT																			3	
	Outside thread	R ¼, DIN 2999																			7	
	Outside thread	M12x1.5, sealed at back, DIN 3852, form E																			5	
Outside thread	M14x1.5, sealed at back, DIN 3852, form E																			6		
Version	Stainless steel without media stopper																				1	
	Stainless steel with media stopper (standard from 4 MPa)																				2	
	Stainless steel with media stopper, free of oil and grease (FPM spec. seal only)										6										3	
	Stainless steel with pressure tip orifice (from 10 MPa)																				5	
Pressure range variation	Indicate W and state range on order (e.g.: W0... + 0.8MPa/OUT1...6V)																			W		

¹⁾ Other pressure range on request

²⁾ Other sealing material on request

³⁾ Delivery without female connector

⁴⁾ Other pressure connection on request

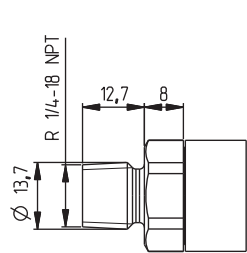

G 1/4
Inside thread

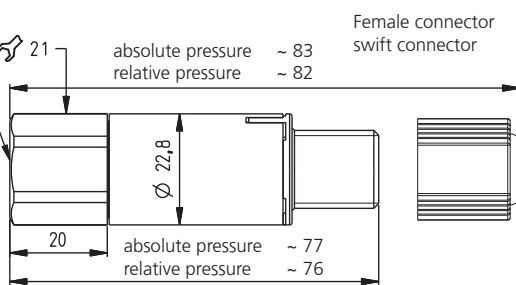

Female connector
swift connector

2 wire
(4 ... 20 mA)

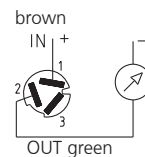

3 wire

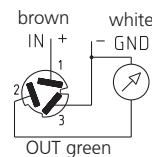

All absolute executions
are especially marked
with an indentation.

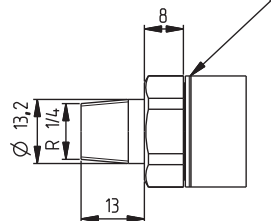

Female connector M12x1

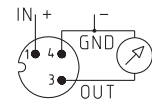
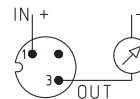
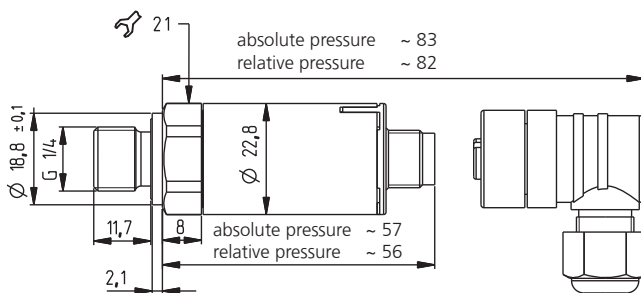

Female connector AMP JPT

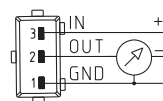
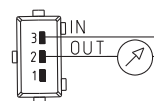
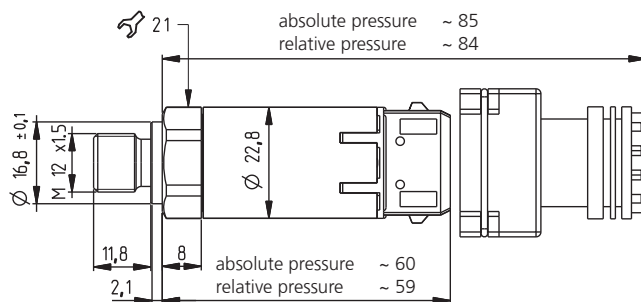
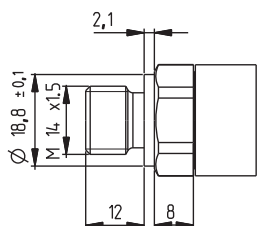

Female connector
DIN EN 175301-803-C

