

Feature

Simple structure and low price

Karman vortex

High temperature water with PPS

Flow rate measurement

Switch output

RoHS

Easy alarm setting with a rotary switch

Switch output

Easy plumbing with quick fasteners

Adapter size Rc3/8

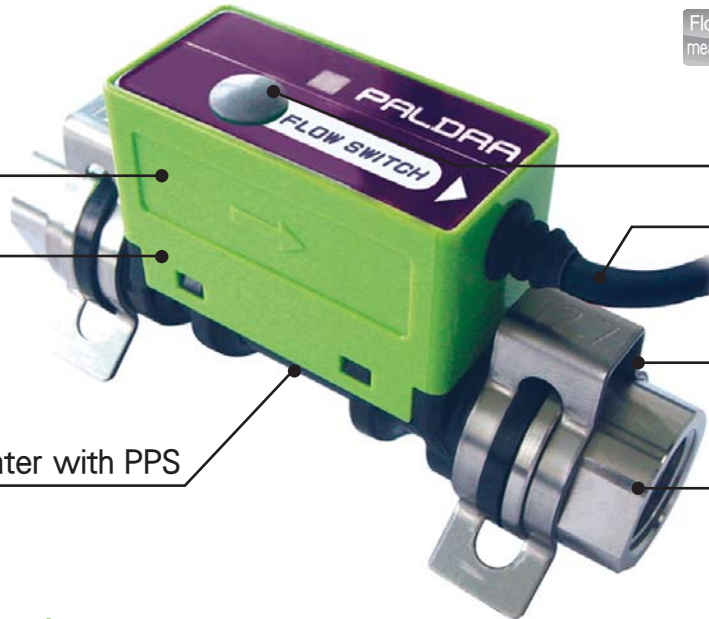

Application example

To control manage flow rate in various cooling water system.

Chiller, temperature controller, mold, machine tool, industrial heating furnace, vacuum heat treating furnace, high frequency wave temper equipment, bag making machine, laboratory high temperature furnace etc.

Cold water or hot water

To control the flow rate of chillers or temperature controlling machines

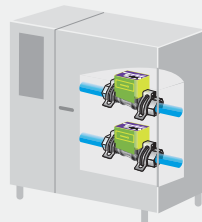

Fluid temperature between 0-90°C is available.

Equipment protection

To control cool water system of temper equipments

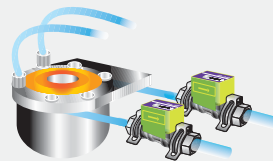

Controlling the flow rate of cooling water system in order to prevent the equipment from overheating

Quality controlling

To control cold water system of bag making machine

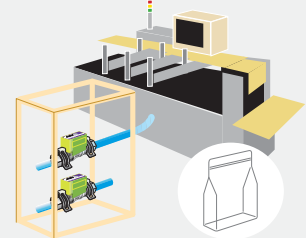

Flow rate of cooling water system for sealed films will be controlled.

Electric wiring

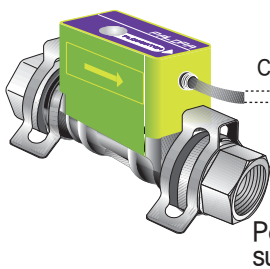

Power supply DC 24V ± 10%

Cable details

- Red Power supply
- Black GND
- White Switch output

Output signals

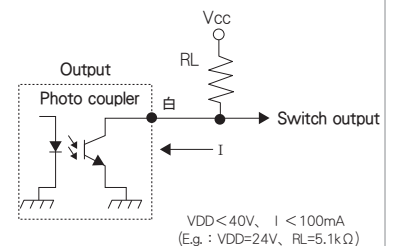

Connect

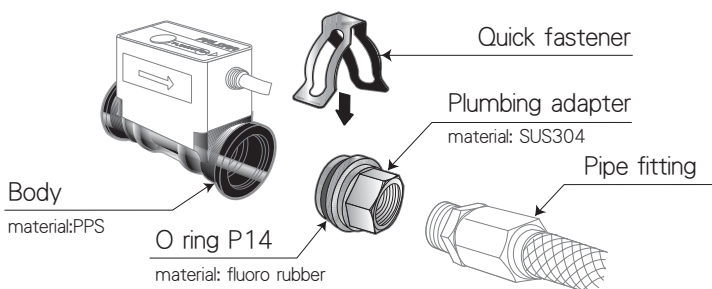

Outline view

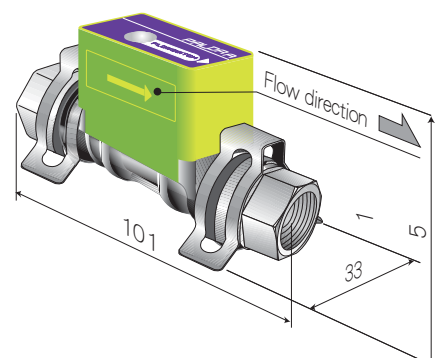

Caution

Please beware of the direct load/pressure on the flow meter (PPS). Remove the quick fastener first and take the adapter out in order to detach the meter from the plumbing, vice versa.

Specifications

Models	PSW-5L	PSW-10L	PSW-30L
Rated flow range	0.5~5.0L/min	1.5~10.0L/min	5.0~30.0L/min
Fluid	Industrial water, water		
Detecting method	Karman vortex		
Fluid temperature	0~90°C (No freezing ,no dewing)		
Ambient temperature	0~50°C (No freezing ,no dewing)		
Maximum working pressure	1.0MPa		
Withstanding pressure	1.5MPa (at 20°C)		
Pressure loss (at the maximum flow rate)	46kPa	60kPa	85kPa
Responsivity	Sampling 0.5s		
Power supply	DC24V±10%		
Current consumption	MAX 20mA		
Switch output	Maximum load current	Max. DC 100mA	
	Maximum applied voltage	Max. DC 40V	
	Output mode	A output	
Display	Alarm: 2colors LED (GRN: Flow rate > Set value RED: Flow rate < Set value)		
Certification, regulation	RoHS		
Wetted material	Body PPS, FKM Adapter SUS304		
Adapter size	Rc3/8" Quick fitting		
Weight	155g		

NOTE: Default setting of switch is 0 memory (0L/min) at the time of shipment.
(Red LED will be on when there is no water flow)

*The design,dimensions and specifications of the product in the catalog were correct at the date of publication and are subjected to change without notice.

*Feel free to contact us if you have any require about our products.

Setting

<Switch output>

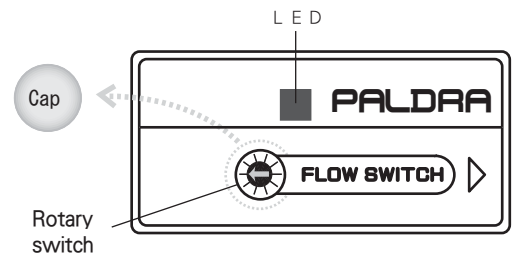

- ① Take a cap out
- ② Set the value with rotary switch
- ③ LED light confirms the Deviation from set value
- ④ Put the cap back on

Point the arrow towards the setting value

E.g. PSW-10L→

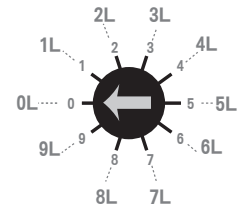

[Flow rate set value diagram]

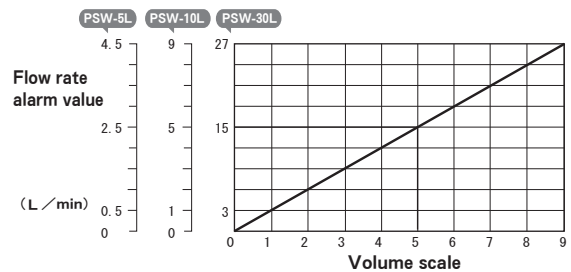

Amount of change per division : PSW- 5 L= 0.5L/min
: PSW-10L = 1L/min
: PSW-30L = 3L/min

Order form

Switch output and LED	
Measuring value \ Switch	A
More than set value	GRN ON / ON
Less than set value	RED ON / OFF

Flow Detected :OUTPUT ON
Flow NOT Detected :OUTPUT OFF

PSW — **5L**
0.5~5L /min
10L
1.5~10L /min
30L
5~30L /min

E.g. PSW-10L